

## James Hardie® Siding Products

### Best Practices – Installation Guide Siding and Trim Products

Version 9 - April 2018

# **FL5**®

Engineered for Climate®

- HardiePlank®
- HardieShingle®
- HardiePanel®
- HardieTrim®
- HardieSoffit®

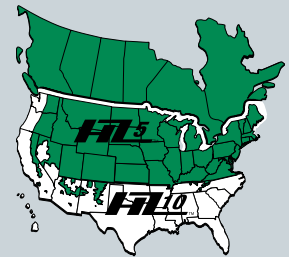

 **JamesHardie**

**ColorPlus**® Technology

## HardieZone® – Engineered for Climate®

James Hardie, the undisputed leader in fiber cement has always made the world's most resilient siding, and now we have made it even better. For the first time, siding has been engineered for climate. So you get the right board for the right climate. We call it the HardieZone® System.

We took the 8 climatic variables – that affect long term performance of the exterior into account and by combining them determined climate zones throughout North America. We found common variables between certain zones which led us to engineer James Hardie siding products for specific climates.

The development of these two products is a result of a heavy investment in R&D and our proprietary technology and manufacturing processes and culminates in the evolution of 7th generation fiber cement – Engineered for Climate.

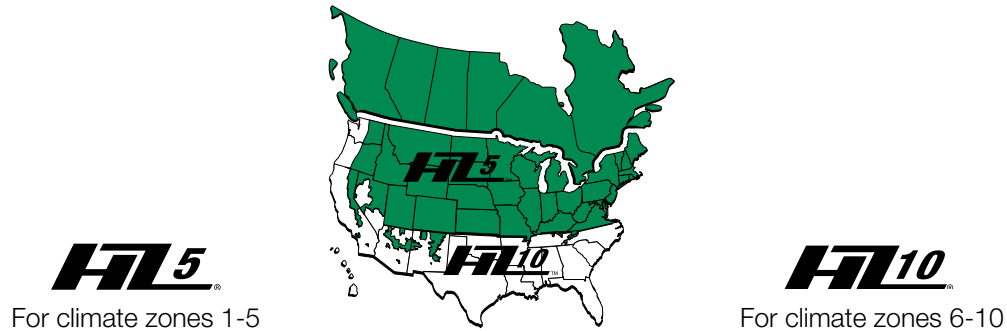

The HZ5® product is engineered to perform in climates with seasonal temperature variations, freezing temperatures and snow and ice.

The HZ10® products are specifically engineered to perform in climates with, high humidity, hot dry conditions and high levels of rainfall.

This guide provides the best practice guidelines for installing the HardieZone product for your zone. Specific details and helpful hints that pertain to your zones are included in order to facilitate your installation process. If you are unsure about which zone your job is located in and which HardieZone product and installation instructions to use, then please visit our website at [jameshardie.com](http://jameshardie.com) for the zip code tool.



### FOREWORD

James Hardie, the world leader in the manufacturing and development of fiber-cement building products, has produced this Installation Guide to help builders and contractors with the installation of James Hardie® siding and trim products, including James Hardie products with ColorPlus® Technology.

The first sections of this manual provide a general product description and information about safe practices, and proper tools for working with James Hardie siding and trim products. Sections that follow describe design and general installation information for specific James Hardie products. The appendix addresses the installation of James Hardie siding products in less common construction practices (e.g. concrete construction).

This manual must be read in conjunction with project drawings and specifications, applicable building codes, and relevant compliance documents. The details in this manual provide guidance on how to comply with James Hardie's installation requirements and need to be reviewed by all parties who are responsible for installing James Hardie products on a project.

**This manual is subject to periodic re-examination and revision. For information on the current status of these documents please check the James Hardie website, [www.jameshardie.com](http://www.jameshardie.com). The reader is responsible for ensuring that they are using the most up-to-date information.**

### TELEPHONE DIRECTORY

**Technical Services** 800-942-7343

**Warranty** 866-375-8603



# Table of Contents

<b>FOREWORD</b> .....	<b>3</b>
<b>GENERAL PRODUCT INFORMATION</b> .....	<b>6</b>
Jobsite Storage of James Hardie® Products .....	6
Importance of Keeping James Hardie Products Dry.....	6
Open Joints Due to Shrinkage.....	6
Difficulty in Handling .....	6
Staining .....	6
Proper Handling of James Hardie Products .....	7
<b>WORKING SAFELY WITH JAMES HARDIE PRODUCTS</b> .....	<b>8</b>
Minimize and Manage Silica Dust .....	8
Work Safe: Product Cutting Instructions .....	8
Cutting Station Set Up.....	9
Clean Up and Disposal of Debris .....	9
<b>TOOLS FOR CUTTING AND FASTENING FIBER-CEMENT</b> .....	<b>10</b>
Shears.....	10
Circular Saws .....	10
Hepa Vacuums.....	11
Power Miter Saws .....	11
Saw Blades .....	11
Jig Saws .....	12
Drilling Fiber Cement .....	12
Lap Gauges.....	12
Joint Flashing .....	13
Power Nailers and Direct-to-Steel Fastening Tools.....	13
Nail Guns and ET&F Guns .....	14
Useful Hand Tools .....	14
<b>GENERAL INSTALLATION REQUIREMENTS</b> .....	<b>15</b>
Framing and Sheathing.....	16
Water-Resistive Barrier .....	17
Staging.....	17
Flashing.....	17
Roof-to-Wall Flashing .....	18
Gutters .....	18
Valley Flashing .....	19
Penetrations .....	19
Hose Bibs .....	20
Hot Air Vents .....	20
Lights and Electrical Outlets .....	21
Wires, Conduits or Other Fixed Pipes .....	21
Air Conditioners, Service Panels and Other Wall Mounted Devices .....	21

Butting to Mortar or Masonry.....	21
Clearances .....	21
Siding to Ground Clearance.....	22
Siding to Flashing Clearance .....	22
Siding and Trim to Solid Surfaces .....	23
Clearances for Sheltered Areas.....	23
Clearance Requirement Examples .....	24-26

## **GENERAL FASTENER REQUIREMENTS** .....

Pneumatic Fastening .....	27
---------------------------	----

## **FINISHING** .....

Finishing James Hardie® Siding and Trim Products .....	28
ColorPlus® Touch-Up.....	28
ColorPlus Products with Protective Laminate Sheet.....	29
Caulk.....	29
Repair Patching.....	29
Back Priming/Back Sealing .....	29
Maintenance.....	30-31

## **HardieWrap®**

### **HARDIEWRAP® PRODUCTS DESCRIPTION** .....

### **INSTALLATION OF HARDIE WRAPS** .....

HardieWrap® Flashing Guide for Typical Penetration .....	34
HardieWrap® Pro-Flashing Guide for Windows .....	34
Storage .....	35
General Requirement.....	35
HardieWrap® Flex Flashing Stretchable Sill Flashing.....	36
Window Installation.....	36
Side Jamb Flashing .....	37
Head Flashing .....	37
Circular Windows .....	38
HardieWrap® Installation Requirements.....	39-44

## **HardieTrim®**

### **HARDIETRIM® PRODUCTS DESCRIPTION** .....

### **INSTALLATION OF HARDIETRIM 4/4, 5/4 & NT3™ BOARDS**.....

Concealed Fastening.....	46
Trimming Corners.....	46
Trim Applications for Windows, Door & Other Openings .....	47
Band Boards .....	47

Fastener Table .....	48
Outside Corners .....	49
Inside Corners .....	49
Band Board .....	50
HardieTrim Board Fastener Specifications .....	50
Window and Door Trim .....	51
Installing Rake and Fascia Board .....	52
Drip Edge .....	52

**INSTALLATION OF HARDIETRIM® BATTENS.....53**

Getting Started .....	53
HardieTrim Battens Fastener Specifications .....	53
Horizontal Joint Treatment .....	54
5/4 & 4/4 HardieTrim HZ10® Installation Requirements .....	55-63
5/4 & 4/4 HardieTrim HZ® Installation Requirements .....	64-72

**HardieSoffit®**

**HARDIESOFFIT® PANEL PRODUCT DESCRIPTION.....73**

**INSTALLATION OF HARDIESOFFIT® PANELS.....74**

Installation of HardieSoffit Panels – Soffit Framing .....	74
Joint Treatment for HardieSoffit Panels .....	74
Framing Prep for Soffit Panels .....	75
Cutting 45° Hip Roof Soffits .....	75
Installing Frieze Boards .....	76
Treatment Options for the Siding/Soffit Juncture .....	76
Insect Screen .....	76
HardieSoffit Fastener Specifications .....	76
Beaded Porch Panel Framing .....	77
Joint Treatment for Beaded Porch Panel .....	77
Handling During Installation .....	78
Siding Beaded Porch Panel Joint .....	78
HardieSoffit Panels Installation Requirements .....	79-81
HardieSoffit Beaded Porch Panel Installation Requirements .....	82-84

**HardiePlank®**

**HARDIEPLANK® LAP SIDING PRODUCT DESCRIPTION.....85**

**INSTALLATION OF HARDIEPLANK LAP SIDING .....86**

Install a Starter Strip .....	86
Installing the Planks .....	87
Plank Alignment at Corners .....	87
Handling .....	87
Blind Nailing .....	88

Face Nailing .....	88
Staggering the Butt Joints .....	88
Joint Flashing .....	89
Joint Placement and Treatment .....	89
Continuing the Installation .....	90
Installing HardiePlank Siding on Gable Walls .....	90-91
HardiePlank Siding Fastener Specifications .....	91
HardiePlank Lap Siding Installation Requirements .....	92-95

**HardieShingle®**

**HARDIESHINGLE® SIDING PRODUCT DESCRIPTION.....96**

**INSTALLATION OF HARDIESHINGLE SIDING.....97**

Individual Shingles .....	97
Shingle Fastener Specifications .....	97
Shingle Panels .....	98
Installing Direct to 7/16 in Sheathing .....	99
Half-Round Shingle Panels .....	99-100
HardieShingle Siding Installation Requirements .....	101-108

**HardiePanel®**

**HARDIEPANEL® VERTICAL SIDING PRODUCT DESCRIPTION.....109**

**INSTALLATION OF HARDIEPANEL VERTICAL SIDING .....110**

Getting Started .....	110
Vertical Joint Treatment .....	111
HardiePanel Siding Fastener Specifications .....	111
Horizontal Joint Treatment .....	112
Windows, Doors, and Other Wall Penetrations .....	113
HardiePanel Vertical Siding Installation Requirements .....	114-116

**APPENDIX A – ADDITIONAL INFORMATION ..... 117-125**

**APPENDIX B – ESTIMATING..... 126-128**

**APPENDIX C – GLOSSARY OF BUILDING TERMS..... 129-130**

**APPENDIX D – CODE REFERENCES ..... 131**

**ESR-1844 & ESR-2290 ONLINE REPORTS..... 132**

# General Product Information

## JOBSITE STORAGE OF JAMES HARDIE® PRODUCTS

The James Hardie family of siding and trim products, including James Hardie® products with ColorPlus® Technology, should be stored in their original packaging in a garage, shed, or in some other covered area protected from weather whenever possible. These products must be kept covered on a pallet off of the ground; they must never be stored in direct contact with the ground.

If James Hardie products are stored outside they should be protected with an additional waterproof covering. All scrap siding and trim pieces, cutoffs or material left on scaffolding must be covered and protected from the elements. If James Hardie products become saturated, they must be laid on a flat surface and allowed to dry completely prior to installation.

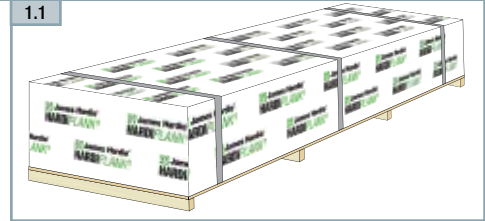

1.1 James Hardie products stored in their original packaging.

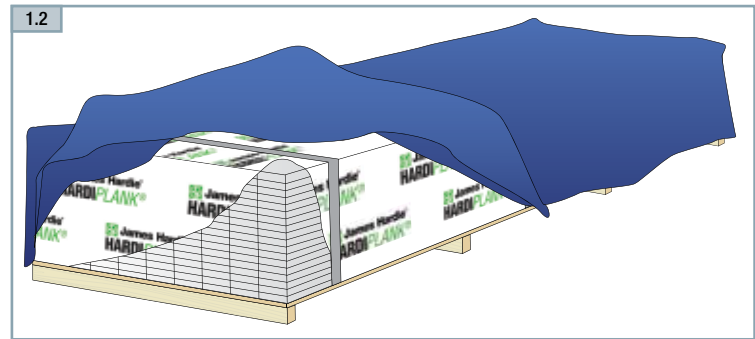

1.2 If stored outside protect with an additional waterproof covering.



### WARNING

James Hardie products should not be rolled-off or dumped-off of the truck during delivery to the jobsite. James Hardie recommends using a fork lift to off load material or unloading by hand.

## IMPORTANCE OF KEEPING JAMES HARDIE PRODUCTS DRY

James Hardie siding and trim products must be kept dry at all times prior to installation. If products become saturated before they are installed, the following problems may occur:

### OPEN JOINTS DUE TO SHRINKAGE

If installed wet, joints between planks may open up requiring repair or replacement. Under normal environmental conditions fiber cement has significantly greater dimensional stability than wood or vinyl-based exterior products.

### DIFFICULTY IN HANDLING

Saturation increases the weight and flexibility of fiber-cement products, making them difficult to handle.

### STAINING

Staining is a deposit of soluble salts, usually white in color, which sometimes appears on the surface of masonry or concrete construction.



### WARNING

James Hardie is not responsible for damage due to improper storage and handling of its products.

## PROPER HANDLING OF JAMES HARDIE® PRODUCTS

To help avoid injury and product damage, lap siding, trim and soffit material should always be carried on edge. James Hardie recommends that these products be carried by two people whenever possible with each person positioned near the end of the load. To carry a plank solo, a person should hold it on edge in the middle with arms spread apart for maximum support of the product. Lifting or carrying lap siding or trim flat may break or bend the product.

James Hardie recommends that two people always carry panel products. Workers should hold the panel near each end and on edge. Because of reduced visibility when handling panel products, take extra care to avoid damaging the corners and edges of the panel.

**TIP:** When handling panel products, manufactured panel carriers or caddies can give workers better control.

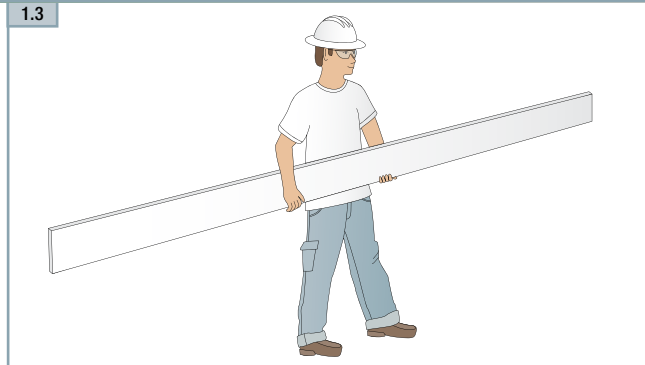

**1.3**  
One person should hold planks on edge in the middle with arms spread apart for maximum support of the product

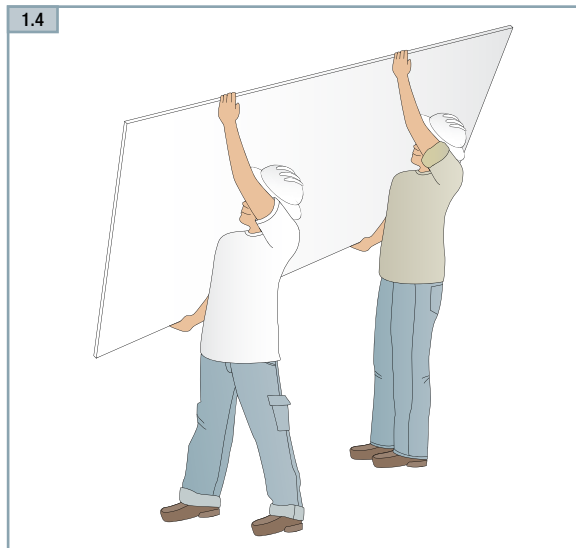

**1.4**  
Two people should always carry panel products.

## WARNING

Carrying James Hardie® ColorPlus® siding products flat may cause excessive bending, which can damage the finish.

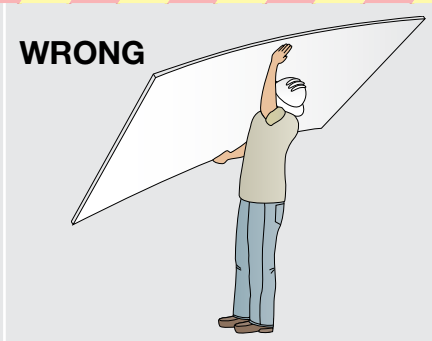
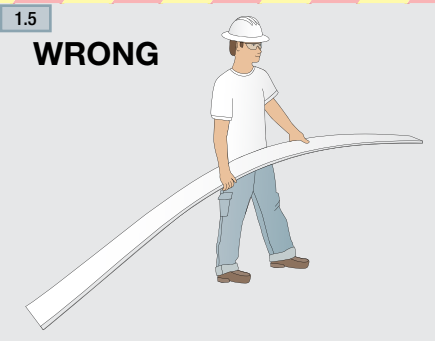

# Working Safely with James Hardie® Products

## MINIMIZE AND MANAGE SILICA DUST

Silica is the most common mineral found on earth. It is the main component of beach sand and is used to make glass and household products such as cleansers and polishes. Silica is also found in many everyday building materials: tile, concrete, granite countertops, drywall compound, masonry bricks, pavers, etc. It is a very durable material and contributes to the stability of fiber cement. Cutting or grinding silica containing materials with high speed saws or grinders can generate very fine (respirable) dust. Over time, long-term occupational over-exposure to respirable silica dust can cause lung diseases including silicosis, lung cancer and other health issues.

OSHA sets exposure limits for dust, chemicals and other materials that employees may be exposed to at work or on a jobsite. These exposure limits cover dust from all types of materials, including: stone, brick, concrete, drywall, wood, and wood composites. OSHA requires employers to take specific actions to protect workers on construction sites based on the amount of silica dust they are exposed to. The updated OSHA standard reduces the permissible exposure limit (PEL) for silica dust by about 80% – from 250 µg/m³ to 50 µg/m³ – over an 8-hour period.

If you have concerns about dust exposure or compliance with OSHA regulations, please contact James Hardie at 1-800-942-7343, or consult with a qualified industrial hygienist (IH). A directory of independent IH consultants can be found at [www.aiha.org](http://www.aiha.org).









## WORK SAFE: FOLLOW JAMES HARDIE PRODUCT CUTTING INSTRUCTIONS

### OUTDOORS

1. Position cutting station so that airflow blows dust away from the user and others near the cutting area.
2. Cut using one of the following methods:
  - a. Best: Circular saw equipped with a HardieBlade® saw blade and attached vacuum dust collection system. Shears (manual, pneumatic or electric) may also be used (not recommended for products thicker than 7/16 in.)
  - b. Better: Circular saw equipped with a dust collection feature (e.g. Roan® saw) and a HardieBlade saw blade.
  - c. Good: Circular saw equipped with a HardieBlade saw blade

### INDOORS

DO NOT grind or cut with a power saw indoors. Cut using shears (manual, pneumatic or electric) or the score and snap method (not recommended for products thicker than 7/16 in.)

	 <p>Shears</p>		
<b>Best</b>	 <p>Circular Saw with vacuum adapter</p>	+	 <p>HardieBlade® Saw Blade</p>
		+	 <p>Vacuum</p>
<b>Better*</b>	 <p>Roan® Dust Collecting Circular Saw</p>	+	 <p>HardieBlade® Saw Blade</p>
<b>Good*</b>	 <p>Circular Saw</p>	+	 <p>HardieBlade® Saw Blade</p>

\*May require proof of compliance (industry reports or exposure testing)



James Hardie ranks options for cutting our fiber cement products in a convenient "Good, Better, Best" chart. The chart on the previous page is provided for informational purposes only to help you in selecting the appropriate cutting options for your particular circumstances. If you are unsure which cutting tools are best for your job site, consult a qualified industrial hygienist or safety professional, or contact your James Hardie representative for assistance.

The Occupational Safety and Health Administration (OSHA) regulates workplace exposure to silica dust. For construction sites, OSHA has deemed that cutting fiber cement outdoors with a circular saw having a blade diameter less than 8 inches and connected to a commercially available dust collection system per manufacturer's instructions results in exposures below the OSHA Permissible Exposure Limit (PEL) for respirable crystalline silica, without the need for additional respiratory protection.

Note: James Hardie makes no representation or warranty that use of a particular cutting option will assure your compliance with OSHA rules or applicable laws and safety requirements.

## CUTTING STATION SET UP

Set up cutting tables or workstations in well ventilated outdoor areas, downwind from other workers. Do not cut indoors or in enclosed areas with high speed saws unless special precautions are taken to prevent overexposure to dust.

### Clean Up and Disposal of Debris

When cleaning up dust and debris from cutting James Hardie® products, never use a broom or brush if the debris material is dry. Use wet dust suppressions methods, sweeping compound, or use a vacuum to collect dust. Waste pieces of James Hardie siding and trim products can be disposed of in landfills according to local ordinances. No special handling is required.

2.1

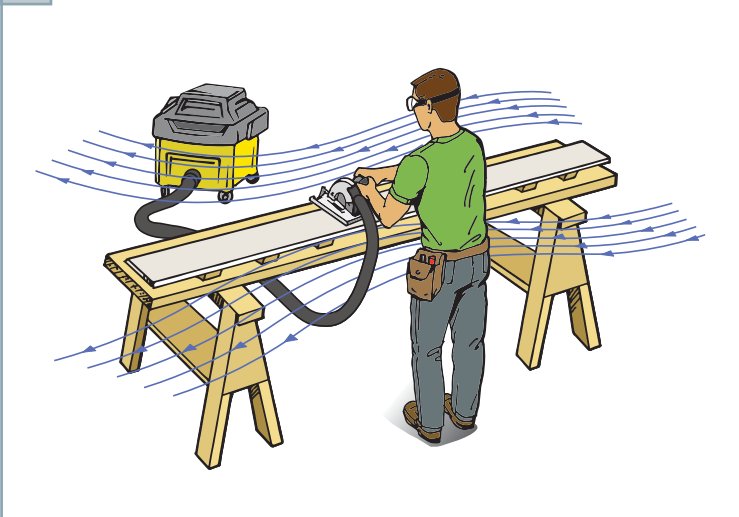

### SILICA WARNING

**DANGER:** May cause cancer if dust from product is inhaled. Causes damage to lungs and respiratory system through prolonged or repeated inhalation of dust from product. Refer to the current product Safety Data Sheet before use. The hazard associated with fiber cement arises from crystalline silica present in the dust generated by activities such as cutting, machining, drilling, routing, sawing, crushing, or otherwise abrading fiber cement, and when cleaning up, disposing of or moving the dust. When doing any of these activities in a manner that generates dust you must (1) comply with the OSHA standard for silica dust and/or other applicable law, (2) follow James Hardie cutting instructions to reduce or limit the release of dust; (3) warn others in the area to avoid breathing the dust; (4) when using mechanical saw or high speed cutting tools, work outdoors and use dust collection equipment; and (5) if no other dust controls are available, wear a dust mask or respirator that meets NIOSH requirements (e.g. N-95 dust mask). During clean-up, use a well maintained vacuum and filter appropriate for capturing fine (respirable) dust or use wet clean-up methods - never dry sweep.

**WARNING:** This product can expose you to chemicals including respirable crystalline silica, which is known to the State of California to cause cancer. For more information go to [P65Warnings.ca.gov](http://P65Warnings.ca.gov).

# Tools for Cutting and Fastening Fiber-Cement Products

James Hardie promotes certain tools and products for the safest and best way to cut their fiber-cement products, consistent with its best practice recommendations (please refer to page 6-7). However, please consult tool manufacturer instructions and guidelines for the safe operation of specific tools. The tools listed here are not made for, or by, James Hardie Building Products, Inc. and James Hardie accepts no liability for their use or misuse.

## SHEARS

Because shears produce less dust than high-speed tools, they are the preferred method of cutting lap and panel siding products. Both electric and pneumatic shears are available, and they may be used for cutting indoors as well as outdoors. Shears are available that can make straight or radius cuts in fiber cement products with relative ease. Shears cannot be used to cut HardieTrim® boards.



**TIP:** For the smoothest cuts, when cutting James Hardie® siding products with a shear or circular saw, cut the board face down. When using a miter saw, cut the board face up. If installing James Hardie siding products with ColorPlus® Technology, leave the protective laminate film in place while cutting.

## CIRCULAR SAWS

When cutting any James Hardie siding, soffit, or trim product with a circular saw, use only tools that are designed specifically for dust reduction. A dust-reducing circular saw has either a deflector to direct any dust away from the user's breathing area or a collection box to capture the dust. James Hardie recommends that a HEPA-equipped vacuum system be used in conjunction with any circular saw. (Circular saws should only be used in outdoor, well-ventilated areas.)



## WARNING

Always make sure the saw manufacturer's safety equipment is in place and in good working order. Never use high-speed power tools when cutting James Hardie® products indoors.

## HEPA VACUUMS

Always use a vacuum equipped with a HEPA filter to help minimize the amount of respirable dust during power saw cutting and clean-up. Many vacuums are designed to connect directly to power tools and run only when the power tool is being operated. In addition to a HEPA filter, using a disposable drywall or collection bag is recommended to extend the life of the HEPA filter and make disposal easier and safer.



## POWER MITER SAWS

Like circular saws, a power miter saw should only be operated outdoors in well-ventilated areas. Power miter saws should be equipped with a HardieBlade® saw blade and should be used in conjunction with a vacuum equipped with a HEPA filter for maximum dust protection.



## SAW BLADES

Traditional blades that are not designed for cutting James Hardie products may generate excessive dust, cut slowly, or exhibit premature wear. The HardieBlade® saw blade is a unique circular saw blade designed to generate less respirable dust than a traditional saw blade or continuous rim diamond blade. The HardieBlade can also be used to cut the full line of James Hardie products and are available in 7 1/4 in., 10 in., and 12 in. diameters. To extend the life of a HardieBlade saw blade, do not use it to cut any materials other than fiber cement.



# Tools for Cutting and Fastening Fiber-Cement Products (cont.)

## JIG SAWS

Jig saws equipped with a fiber-cement cutting blade may be used to cut service openings, curves, radii, scrollwork, and other irregular shapes in James Hardie® products. Because most jig saws are not equipped with dust collection capabilities, these tools also should only be used outdoors in well-ventilated areas and for limited amounts of cutting.



## DRILLING FIBER CEMENT

When required to drill a hole in fiber cement products, a masonry bit should be used. For larger holes, a carbide tipped hole saw can be used. Due to the lack of dust collection, drills and hole saws should only be used outdoors in well-ventilated areas and for limited amounts of cutting. For best results, use a hole saw specifically designed for fiber cement.



[www.malcoproducts.com](http://www.malcoproducts.com)

## LAP GAUGES

Several different methods exist to ensure proper spacing and overlap of fiber cement products. The slowest method is to snap a chalk line with the proper spacing above each row of fiber cement as it is being installed. The siding gauge leads all other alignment devices in ease of use, speed, and effectiveness. James Hardie recommends the use of siding gauge when installing lap siding. When installing HZ5®, special care must be taken when using lap gauges so the drip edge is not damaged. For best results, use a Siding Gauge that is specifically designed for HZ5®.

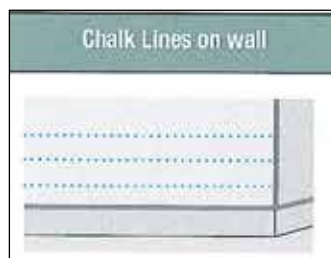

## JOINT FLASHING

Flashing behind butt joints provides an extra level of protection against the entry of water at the joint. James Hardie recommends 6 in. wide flashing that overlaps the course below by 1 in. Some local building codes may require different size flashing. Joint-flashing material must be durable, waterproof materials that do not react with cement products. Examples of suitable material include finished coil stock and code compliant water-resistive barriers. Other products may also be suitable.

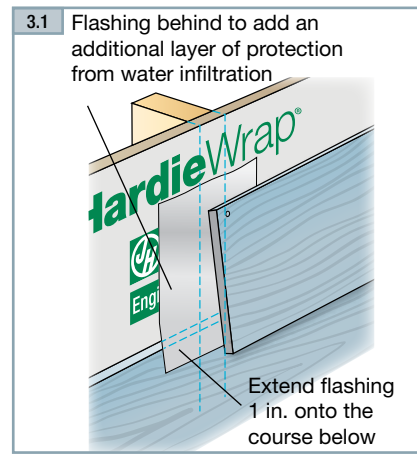

## POWER NAILERS AND DIRECT-TO-STEEL FASTENING TOOLS

Pneumatic nailers and cordless nailers can be used to attach James Hardie products to wood, steel, or masonry substrates. Pneumatic tools require the use of an air compressor with a hose. Finish nailers should be used for HardieTrim® boards only. Additionally, direct-to-steel tools such as those made by ET&F are designed specifically for fastening to steel framing. Refer to the product-specific installation instructions in each section for fastener choices.

Power nailers recommended for attaching James Hardie products are siding nailers, roofing nailers and finish nailers. Below is a chart showing the appropriate nailer for each of the James Hardie siding and trim products. Be sure that the nailer chosen fires the fastener recommended for each product for the specific installment situation.

### PNEUMATIC NAILER USAGE WITH JAMES HARDIE® PRODUCTS

#### Siding Guns



- HardiePlank® Lap Siding
- HardiePanel® Vertical Siding
- HardieShingle® Panels
- HardieSoffit® Panels

#### Roofing Guns



- HardiePlank® Lap Siding
- HardiePanel® Vertical Siding
- HardieShingle® Panels

#### Finish Guns



- HardieTrim® 5/4, 4/4 Boards
- HardieTrim® Batten Boards

**TIP:** If framing nailers are used to install James Hardie products, be sure they are fitted with a flush mount attachment to control nail seating depth.

# Tools for Cutting and Fastening Fiber-Cement Products (cont.)

## NAIL & PIN GUNS

Pneumatic nail guns can be used to attach James Hardie products to wood, steel or masonry substrates. Finish nail guns can be used for HardieTrim® board only. Refer to the product specific installation instructions for fastener choices. Below are examples of commonly used nail guns.

Hitachi ([www.hitachipowertools.com](http://www.hitachipowertools.com))\*

(NT65A2) 2½ in. 16 gauge Finish Nailer  
(NV65AH) 2½ in. Siding Nailer  
(NV45AB2(S)) 1¾ in Coil Roofing Nailer  
(NV75AG) 3 in Coil Nailer

Dewalt ([www.dewalt.com](http://www.dewalt.com))\*

(D51257K) 1¼ in - 2½ in. 16 Gauge Straight Finish Nailer Kit

ET&F Fastening Systems ([www.etf-fastening.com](http://www.etf-fastening.com))\*

(500) Nailer to Steel Studs  
(510) Nailer to Steel Studs  
(610) Nailer to Steel Studs  
(110) Finish Nailer to Steel Studs

Duo-Fast ([www.duo-fast.com](http://www.duo-fast.com))\*

(P275C) Siding Coil Nailer

Porter Cable ([www.deltaportercable.com](http://www.deltaportercable.com))\*

(COIL250) 2½ in. Coil Nailer

Aerosmith ([www.AerosmithFastening.com](http://www.AerosmithFastening.com))

(ST4100/ST4200) Nailer to Steel Studs  
(HN120) Nailer to Masonry  
Requires special high pressure air compressor model number AKHL1050E



NV65AH



NT65A2



NV45AB2(S)



NV75AG



DC616KA†



P275C



ET&F 510



610 ET&F



110 ET&F



ST4100/  
ST4200



HN120

## USEFUL HAND TOOLS

In addition to the power tools listed above, certain hand tools are necessary for the installation of James Hardie® siding and trim products. These include:

- 25 ft. contractors tape measure
- Torpedo level
- Pencil or pen
- Smooth-faced hammer
- Speed square
- 4 ft. or longer level

**TIP:** If hand nailing, use a smooth faced hammer to avoid marking the product. Waffle-headed hammers should not be used when hand nailing James Hardie siding and trim products.

# General Installation Requirements

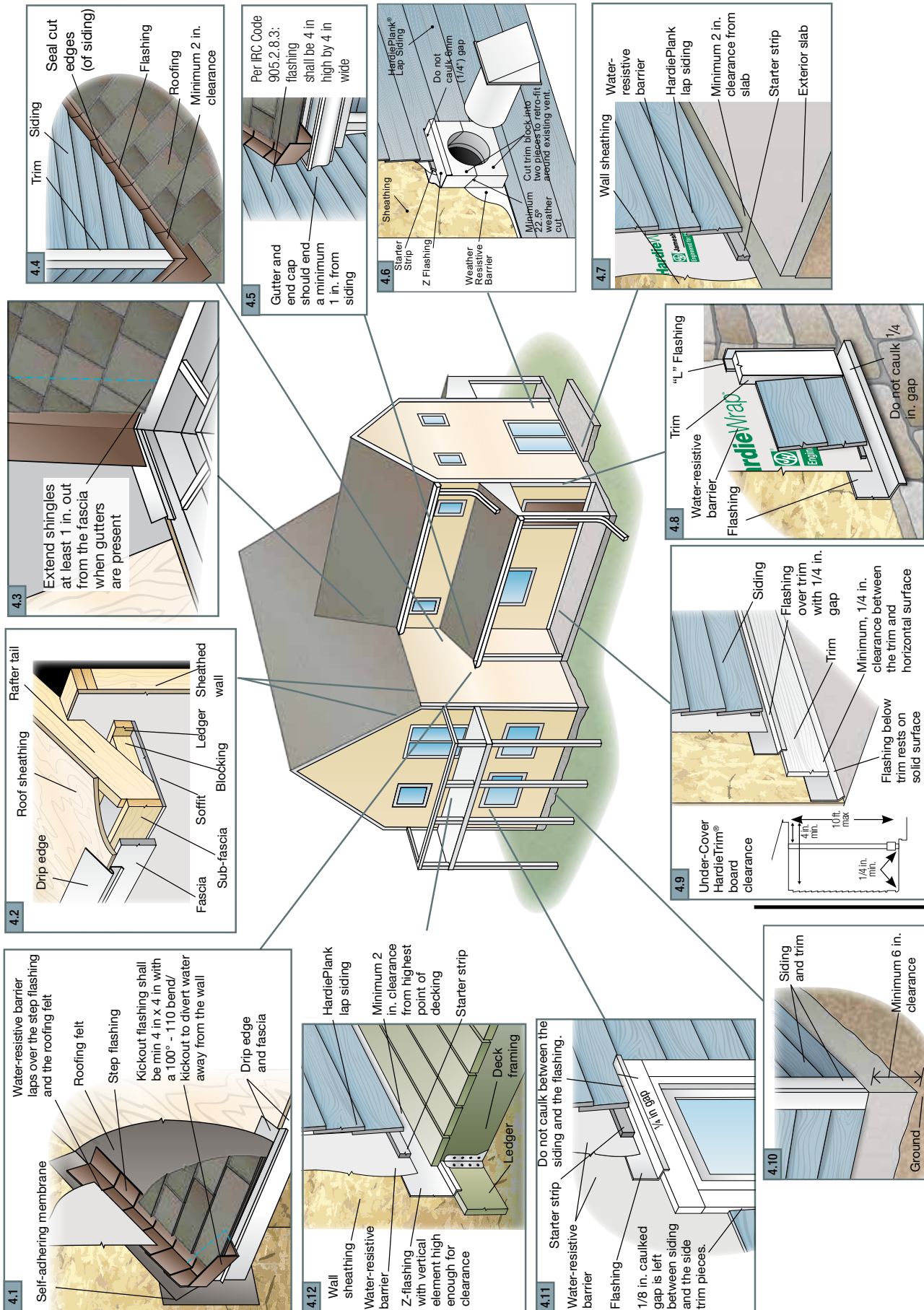

General Product Information	Working Safely	Tools for Cutting and Fastening	General Installation Requirements	General Fastener Requirements	Finishing and Maintenance	HardieWrap® Weather Barrier	HardieTrim® Boards/Battens	HardieSoffit® Panels	HardiePlank® Lap Siding	HardieStingle® Siding	HardiePanel® Vertical Siding	Appendix/ Glossary	ESR-1844 & 2290 Report
-----------------------------	----------------	---------------------------------	-----------------------------------	-------------------------------	---------------------------	-----------------------------	----------------------------	----------------------	-------------------------	-----------------------	------------------------------	--------------------	------------------------

# General Installation Requirements

## FRAMING AND SHEATHING

Refer to the appendix for more information on rigid foam insulation.

James Hardie® siding and trim products can be installed over braced wood or steel studs spaced at a maximum of 24 in. on center or directly to 7/16 in. thick OSB or equivalent sheathing. These products can also be installed over solid-foam insulation board up to 1 inch thick.

Irregularities and unevenness in framing, sheathing, foam and other wall assembly components, including under driven nails, can telegraph through to the finished siding and trim. These irregularities should be corrected before the siding is installed.

When installing James Hardie siding and trim products over steel studs James Hardie requires a minimum 20 gauge and recommends a maximum of 16 gauge. Steel framing that is outside of this range may be too flimsy to provide adequate holding power or too heavy for some fastening systems.

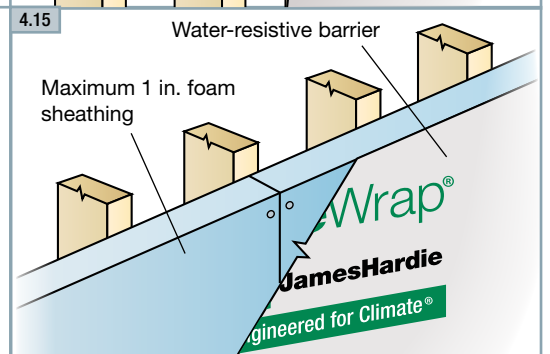
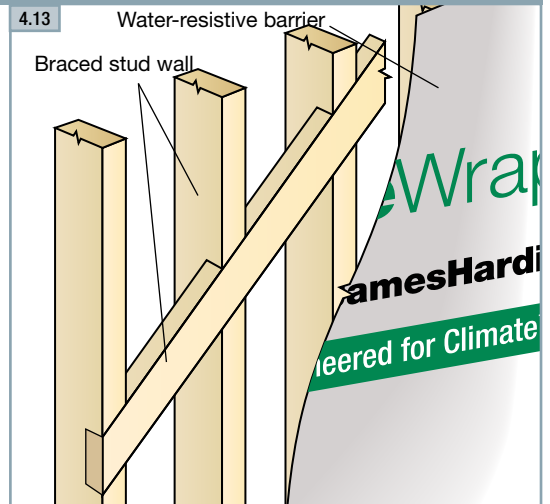
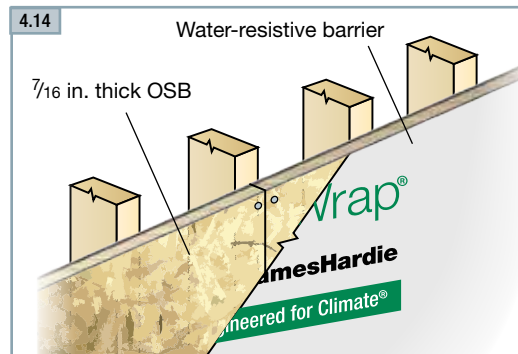

When using pins to attach siding products to steel, it is important to hold the material tight to the steel framing when driving the pin as the pin will not pull the material tight to the framing the same as a nail into wood will. Once the pin has been driven into the steel stud it is also important to not set or hit the nail a second time with a hammer. When driven into steel, the ballistic-shaped point uniformly pierces the steel instead of drilling it out or tearing the steel. The displaced steel rebounds around the pin to create a strong compressive force on the shank of the pin. When the pin is hit with a hammer it disrupts the compressive and frictional forces holding the pin and significantly reduces the overall holding capacity of the pin. If the pin does not set properly during the first attempt, the pin should be removed and replaced with a second pin.

When using a screw to attach James Hardie products to steel, a screw with a self tapping point should be used. A self tapping screw functions by having a cutting edge which drills away the material, making a tiny hole for the screw to go into. Some self tapping screws may be wing tipped which are intended to bore out the fiber cement (creating a pilot hole), and will break off as the screw goes into the steel. Either type of screw is acceptable for use.

Refer to the correct code compliance reports when selecting a fastener for steel applications and choose the corresponding tools from the tool section of this guide.

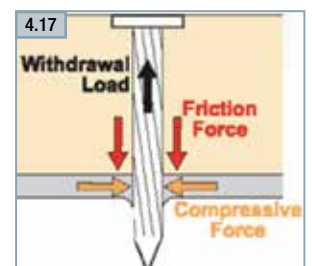
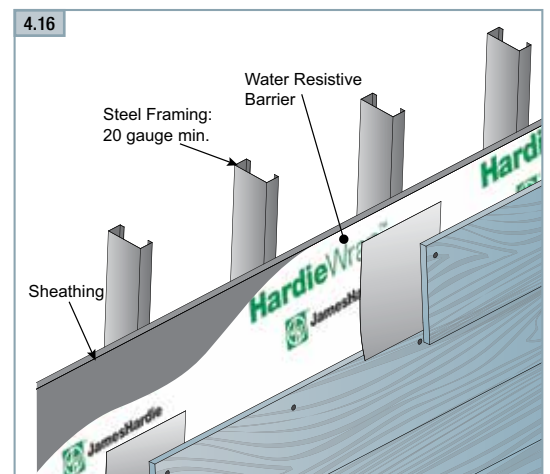



## WATER-RESISTIVE BARRIER

Prior to siding, make sure the water-resistive barrier is properly installed according to the manufacturers' instructions. Refer to page #30 for more information on HardieWrap® weather barrier including complete installation requirements.

IBC Code Reference: "1403.2 Weather protection. Exterior walls shall provide the building with a weather-resistant exterior wall envelope. The exterior wall envelope shall include flashing, as described in Section 1405.3. The exterior wall envelope shall be designed and constructed in such a manner as to prevent the accumulation of water within the wall assembly by providing a water-resistive barrier behind the exterior veneer, as described in Section 1404.2, and a means for draining water that enters the assembly to the exterior. Protection against condensation in the exterior wall assembly shall be provided in accordance with the International Energy Conservation Code.

Exceptions:

1. A weather-resistant exterior wall envelope shall not be required over concrete or masonry walls designed in accordance with Chapters 19 and 21, respectively.
2. Compliance with the requirements for a means of drainage, and the requirements of Sections 1404.2 and 1405.3, shall not be required for an exterior wall envelope that has been demonstrated through testing to resist wind-driven rain, including joints, penetrations and intersections with dissimilar materials, in accordance with ASTM E 331 under the following conditions. . . ."

## STAGING

Heavy building products and components such as roofing, drywall and floor coverings should be stored throughout the structure prior to the installation of the siding. Distributing the weight in this manner will reduce the possibility of floor plate compression on two or more story homes.

## FLASHING

When using James Hardie siding, trim, and weather barrier products, make sure that roof flashing, water table flashing, window and door flashing, and flashing for other building envelope penetrations are properly installed and lapped so that moisture drains down and to the exterior. Note: The successful installation of flashing requires thorough planning before installation of roofing or siding. Scheduling and sequencing are important factors as well as having the correct flashings available on site at the correct time. James Hardie does not recommend the use of mill finished, raw aluminum flashing or any other product that may bleed or adversely react with cement products. Painted or coated aluminum flashings are recommended.

Manufacturers of ACQ and CA preservative-treated wood recommend spacer materials or other physical barriers to prevent direct contact of ACQ or CA preservative-treated wood and aluminum products. Fasteners used to attach HardieTrim Tabs to preservative-treated wood shall be of hot dipped zinc-coated galvanized steel or stainless steel and in accordance to 2009 IRC R317.3 or 2009 IBC 2304.9.5.

IBC Code Reference: "1405.3 Flashing. Flashing shall be installed in such a manner so as to prevent moisture from entering the wall or to redirect it to the exterior. Flashing shall be installed at the perimeters of exterior door and window assemblies, penetrations and terminations of exterior wall assemblies, exterior wall intersections with roofs, chimneys, porches, decks, balconies and similar projections and at built in gutters and similar locations where moisture could enter the wall. Flashing with projecting flanges shall be installed on both sides and the ends of copings, under sills and continuously above projecting trim."

# General Installation Requirements (cont.)

## ROOF-TO-WALL FLASHING

Due to the volume of water that can run down a sloped roof, one of the most critical flashing details is where a roof intersects with a sidewall. Install a self-healing adhesive-backed membrane along the roof/wall intersection before flashing. The membrane on the wall should extend behind the eaves framing and should be installed before the sub-fascia or trim goes on.

The roof should then be flashed to the wall with step flashing positioned at every shingle course. Where the roof begins at its lowest point, install a kickout flashing to deflect water away from the siding. Kickout flashing can be made by cutting and bending a piece of step flashing at an angle. The water-resistive barrier on the wall should then lap over the step flashing.

There are several companies that sell pre-made kickout flashings that are designed to divert water away from the wall. Below is an example of a preformed polypropylene kickout. Be sure to follow all manufacturer's installation instructions.

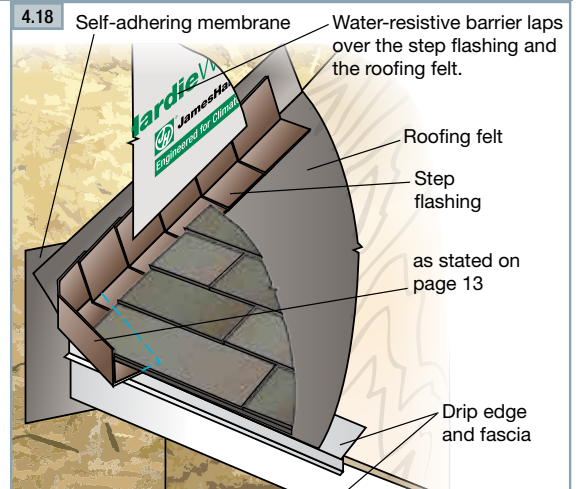

Copyright © 2009 DryFlekt. All rights reserved.

## **WARNING**

**Caution: The kickout flashing shall be min 4 in x 4 in as required by IRC code R905.2.8.3 and be angled between 100° - 110° to deflect water from dumping behind the siding and the end of the roof intersection**

## GUTTERS

If gutters are installed, they should not terminate against siding or trim. Maintain a 1 in. clearance between the siding and the gutter end-cap. Kickout flashings should be installed on the roof above to divert roof runoff into the gutters and away from the 1 in. gap.

The amount of water that can be generated from a rain shower or storm can be substantial. Managing the collection and distribution of this water is important over the life of a home.

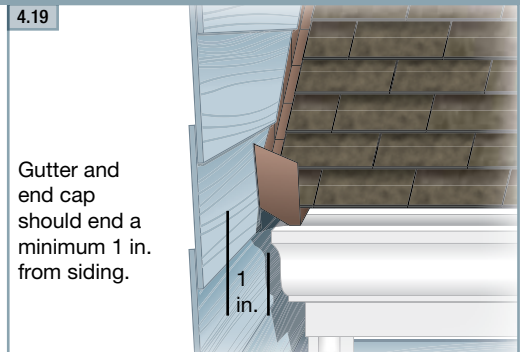

**Code Reference:** "1503.2.1 Locations. Flashing shall be installed at wall and roof intersections, at gutters, wherever there is a change in roof slope or direction and around roof openings..."

**TIP:** James Hardie recommends the use of rain gutters whenever possible.

## VALLEY FLASHING

For added protection at roof valleys, James Hardie requires one of the following options:

1. If rain gutters are present: As the roof is being shingled, have the roofer extend the shingles at least 1 in. out from the fascia to direct water directly into the gutters (figure 4.20-A).
2. If rain gutters not present: When rain gutters are not present, have the roofer extend the valley flashing at least 2 in. out from the corner to direct water further away from the building (figure 4.20-B).
3. If the roof is already flashed and shingled, add a short piece of flashing to extend the valley in compliance with figure 4.20-B.

The above requirement also applies to roof valley's at any other locations where the fascia runs into a roof line such as dormer valleys and roof-to-roof intersections.

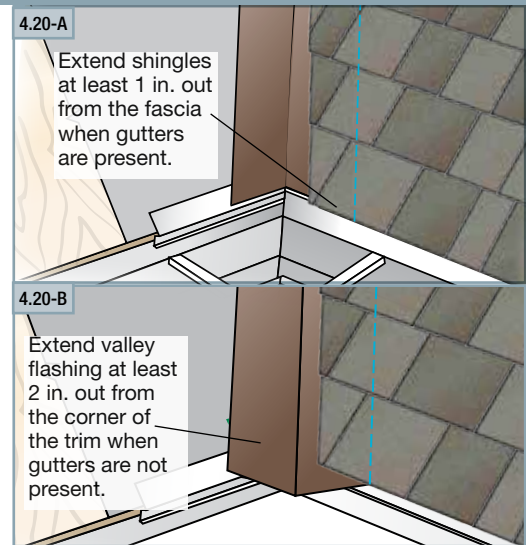

## PENETRATIONS

For penetrations in the building envelope such as hose bibs and holes 1½ in diameter or larger, such as dryer vents, a block of HardieTrim® 5/4, 4/4 boards shall be installed around the point of penetration. Blocking **should** be a minimum 3 in radius greater than the radius of the penetration. To install a block around an existing vent pipe, it may be necessary to cut the block into two pieces. In this case, weather-cut the trim to fit it into place. Install flashing over the top of the trim block.

Penetrations through a building envelope are made to accommodate needs such as hose bibs, dryer and furnace vents, electrical conduit, etc. It is important to restore the weather-resistant barrier of the home after cutting a hole for the penetration.

There are several pre-made blocking and flashing products available that can simplify the installation of a penetration. One such example is Sturdimount®. Be sure to follow all manufactures installation instructions.

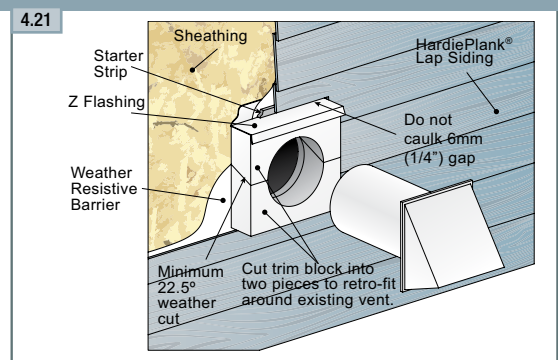

**SturdiMount.**

**TIP:** As most penetrations will require blocking and flashing, some planning is required. As the trim is ordered for the home, don't forget to order some extra to serve as blocking.

# General Installation Requirements (cont.)

## HOSE BIBS

Hose bibs are a source of water which increases the likelihood of moisture related problems. The goal is to keep the water outside of the building and the best way to do this is keep the water off the walls. A good preventative measure is to extend the hose bib further from the wall. A downward slope on the water pipe as it leaves the building will also encourage any slow leaks to fall away from the home.

Large piping over 1½ in. diameter is required to have blocking and flashing at the penetration. A block of HardieTrim® 5/4, 4/4 boards should be installed around the point of penetration. To install a block around an existing pipe, it may be necessary to cut the block into two pieces. In this case, weather-cut the trim to fit it into place. Install flashing over the top of the trim block.

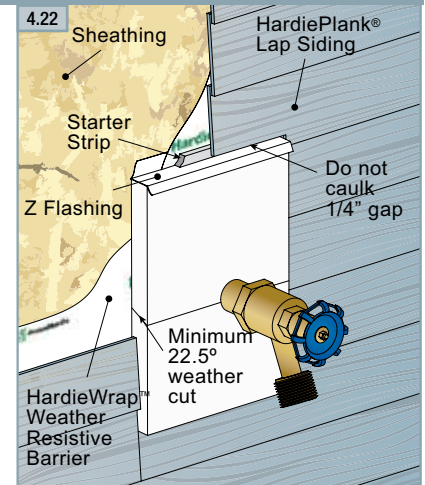

## HOT AIR VENTS (Dryer, Stove, Furnace, Heater, Etc.)

For hot air vents including dryer vents, stove vents, and furnace and heater exhaust, it is important to move the air away from the building envelope. As the vent is installed, a path for that moisture to leave the area should be identified. Consider what is being vented and where it is going before installing the vent. For instance, a dryer vent directly under an eave is going to force hot, moist air to rise and collect at the soffit. A good preventative measure for many vents is to increase the distance they extend from the wall to help expel moisture from the building.

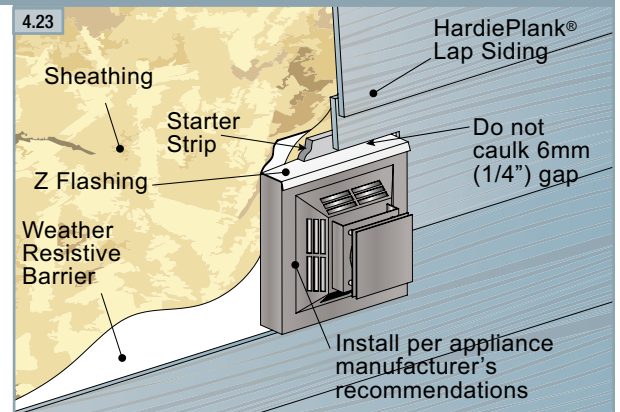

For dryer vents, avoid placement too low to the ground where debris could easily impede air flow, trapping heat and moisture. Some types of high efficiency furnaces can be vented out through the walls. In these cases, avoid locating the vent too close to the roof or eaves where heat and moisture will be trapped.

**TIP: Consider location of the vent prior to installation and consider extending the vent further from the wall.**

Any vent piping is required to have blocking and flashing at the penetration. A block of HardieTrim® 5/4, 4/4 boards should be installed around the point of penetration. The blocking should extend 3-4 in. along the wall from the edge of the vent. To install a block around an existing vent, it may be necessary to cut several blocks, with weather-cuts on each piece. Flashing must be installed over the top of the trim block.

## LIGHTS AND ELECTRICAL OUTLETS

Lights and Electrical boxes should have the same flashing and blocking as other large penetrations such as vents. Many lights utilize square electrical boxes. Blocking a square object should still incorporate the best practices of an angled weather cut.

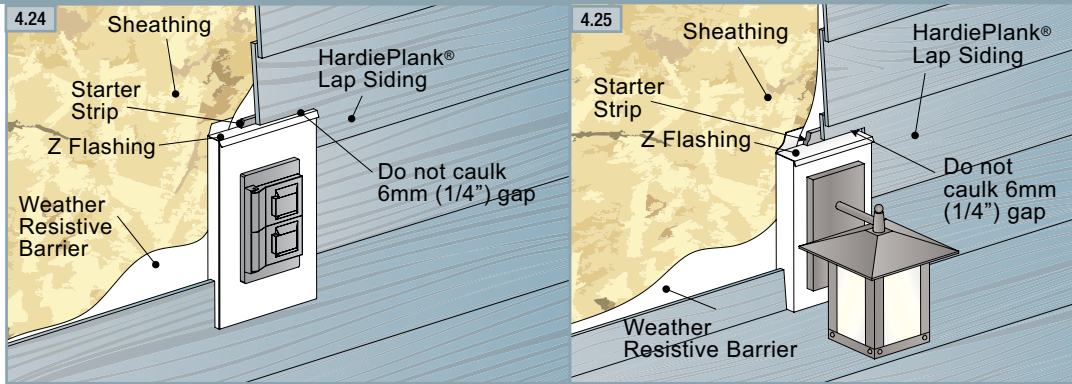

## WIRES, CONDUIT OR OTHER FIXED PIPES

For small penetrations such as wires, electrical conduit, and pipes less than 1 1/2 in. in diameter (excluding hose bibs) no blocking is necessary. The circumference of pipe or wire should be sealed with a barrier foam and/or caulked.

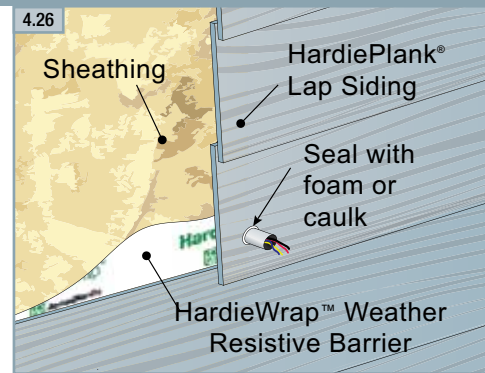

## AIR CONDITIONERS, SERVICE PANELS, AND OTHER WALL MOUNTED DEVICES

Wall mounted devices and air conditioners represent large penetrations into the building envelope and structure. Before installing a unit, please consult the architect or structural engineer to determine if additional bracing is necessary. The device should be installed per manufactures instructions and flashed properly. Any condensate drains should extend out 4 in from the wall, and angle down.

## BUTTING TO MORTAR OR MASONRY

James Hardie® siding and trim products should not be butted directly against mortar or masonry, including stone, brick, or concrete block. In these situations, a flashing should be installed to isolate the trim or siding from the mortar or masonry.

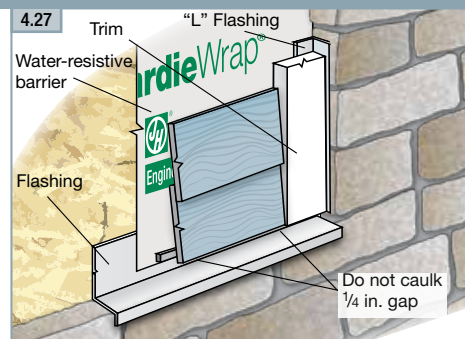

## CLEARANCES

James Hardie specifies clearances to ensure the long-term durability of their products and the buildings on which they are installed. Failure to provide the proper clearances, as specified below, may affect performance of the building system, violate building codes or James Hardie requirements, and may void any warranty on the products.

# General Installation Requirements (cont.)

## SIDING TO GROUND CLEARANCE

James Hardie products must be installed with a minimum of 6 in. clearance to the ground on the exterior of the building. Clearances greater than 6 in. may be required in accordance with local building codes. Foundations are typically required to extend above the adjacent finished grade a minimum of 6 in. or as required by local building codes.

**IBC Code Reference:** “1803.3 Site grading. The ground immediately adjacent to the foundation shall be sloped away from the building at a slope of not less than one unit vertical in 20 units horizontal (5-percent slope) for a minimum distance of 10 feet (3048 mm) measured perpendicular to the face of the wall...”

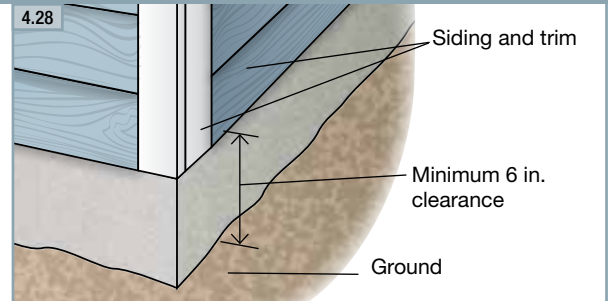

## SIDING TO FLASHING CLEARANCE

A 1/4 in. clearance must be maintained between James Hardie® siding and trim products and any horizontal flashing.

All horizontal flashing should be installed with a positive slope in such a way that it promotes proper drainage and does not allow moisture to pool on top of the flashing.

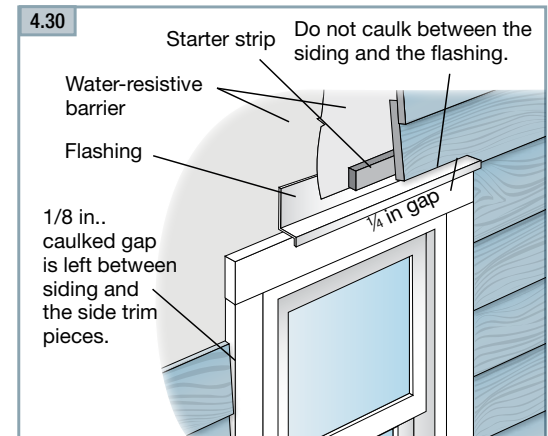
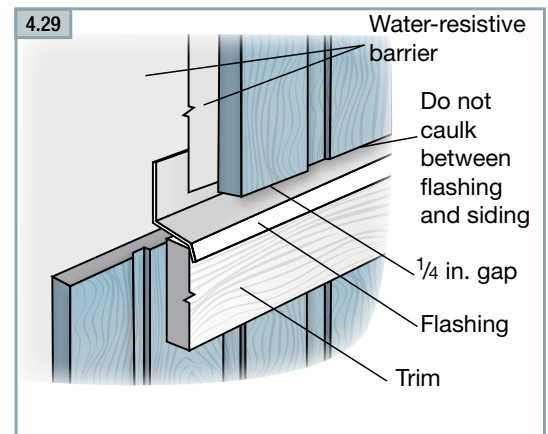

## SIDING AND TRIM TO SOLID SURFACES

A clearance of 2 in. must be maintained between James Hardie siding and trim products where they meet roofs, decks, paths, steps, driveways or any other solid surfaces.

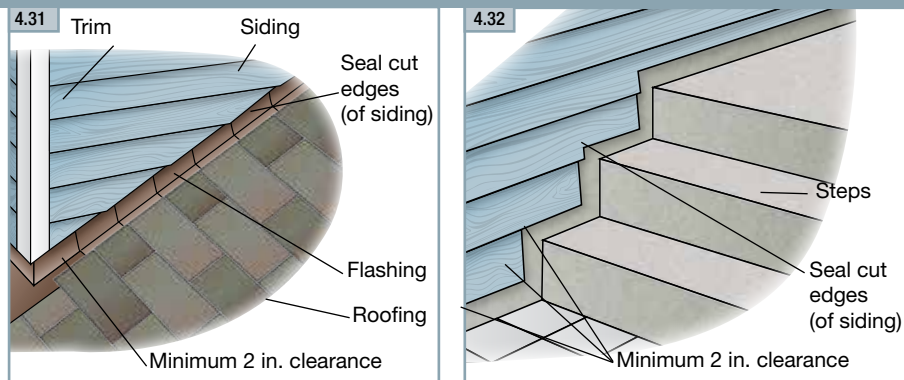

Code Reference: "1503.2.1 Locations. Flashing shall be installed at wall and roof intersections, at gutters, wherever there is a change in roof slope or direction and around roof openings..."

IRC Code Reference: "905.2.8.3 Sidewall flashing. Base flashing shall be continuous or step flashing shall be a minimum of 4 in. in height and 4 in. in width"

## CLEARANCES FOR SHELTERED AREAS

Maintain a 1/4 in. clearance for HardieTrim boards installed under cover. Under cover is defined as:

- Not more than 10 feet below a roof overhang, and
- Not less than 4 inches horizontally from the edge of the roof overhang

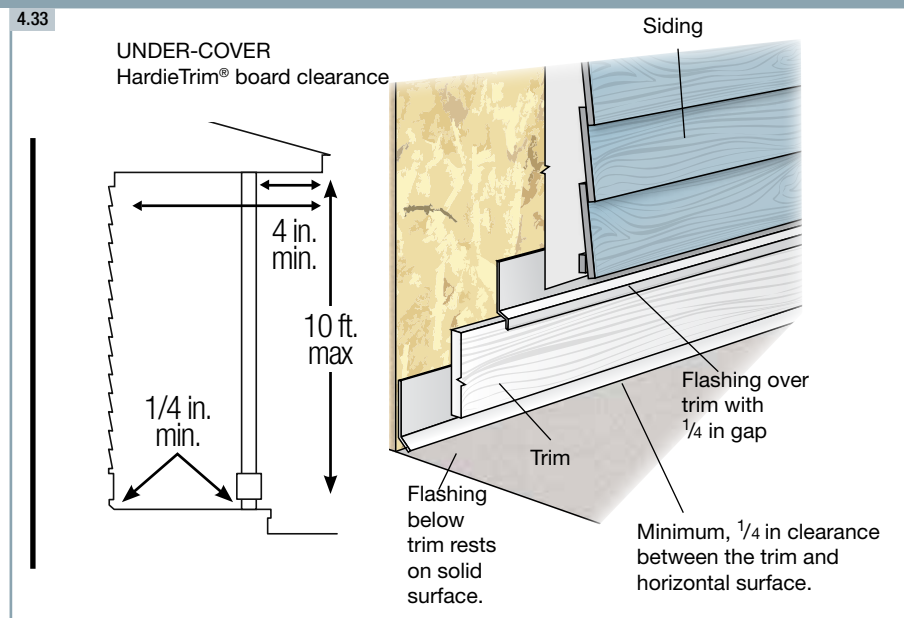

**WARNING**  
 James Hardie siding and trim products must not be installed such that they remain in contact with standing water.

# General Installation Requirements (cont.)

Here are examples of details that can help improve the aesthetics of clearance requirements. Check with a design professional and local building officials to ensure that the chosen details are correct for their intended purpose and location.

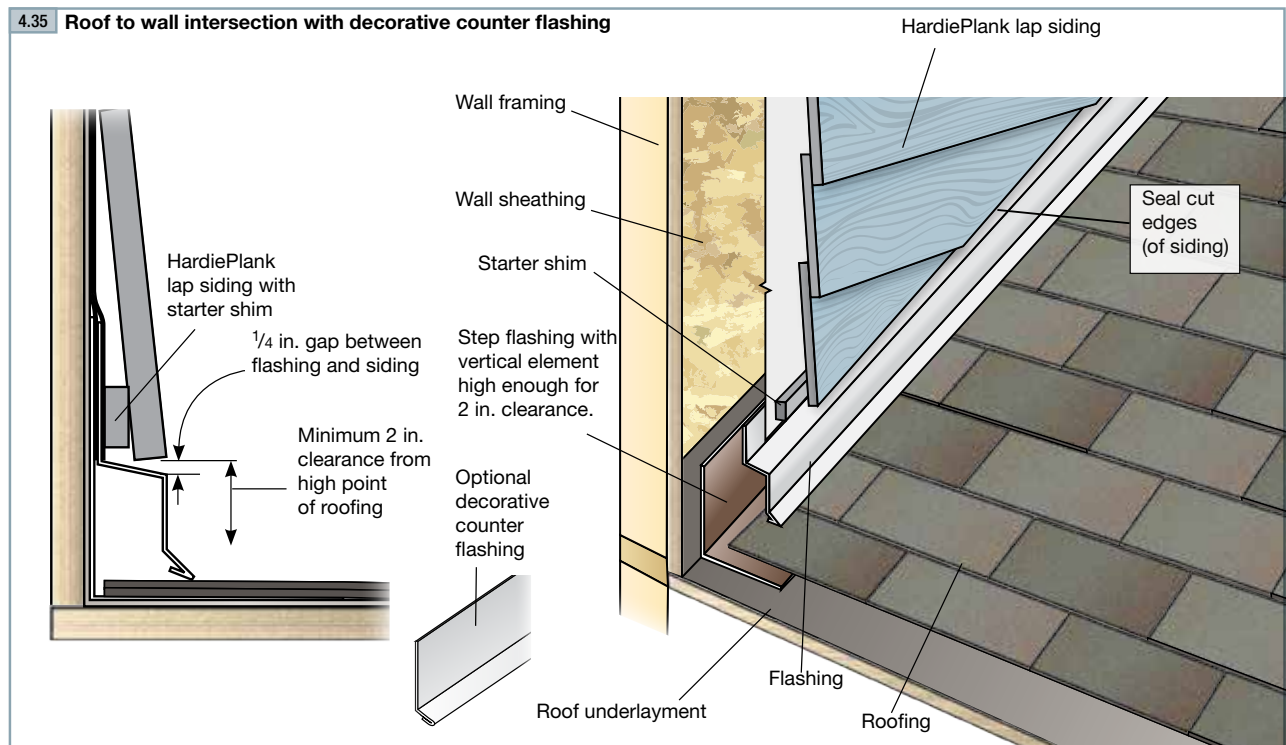
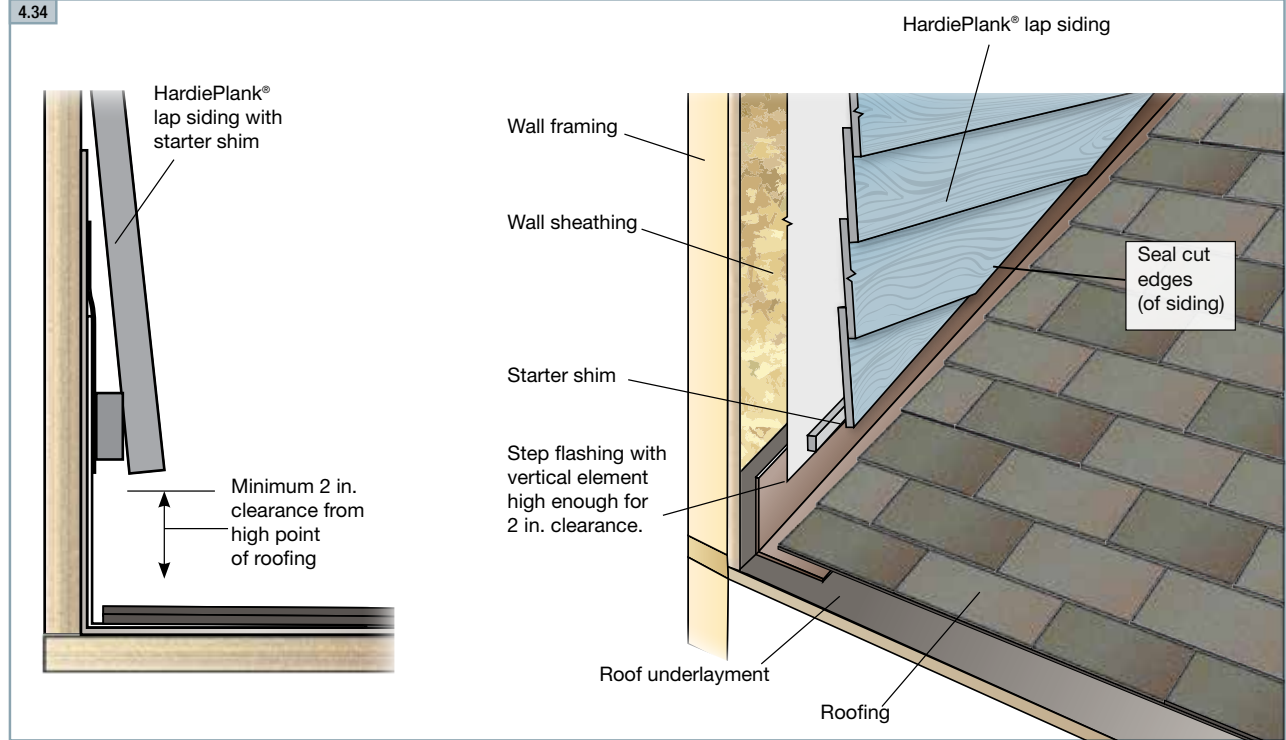



4.36 Wall to exterior slab intersection without decorative counter flashing

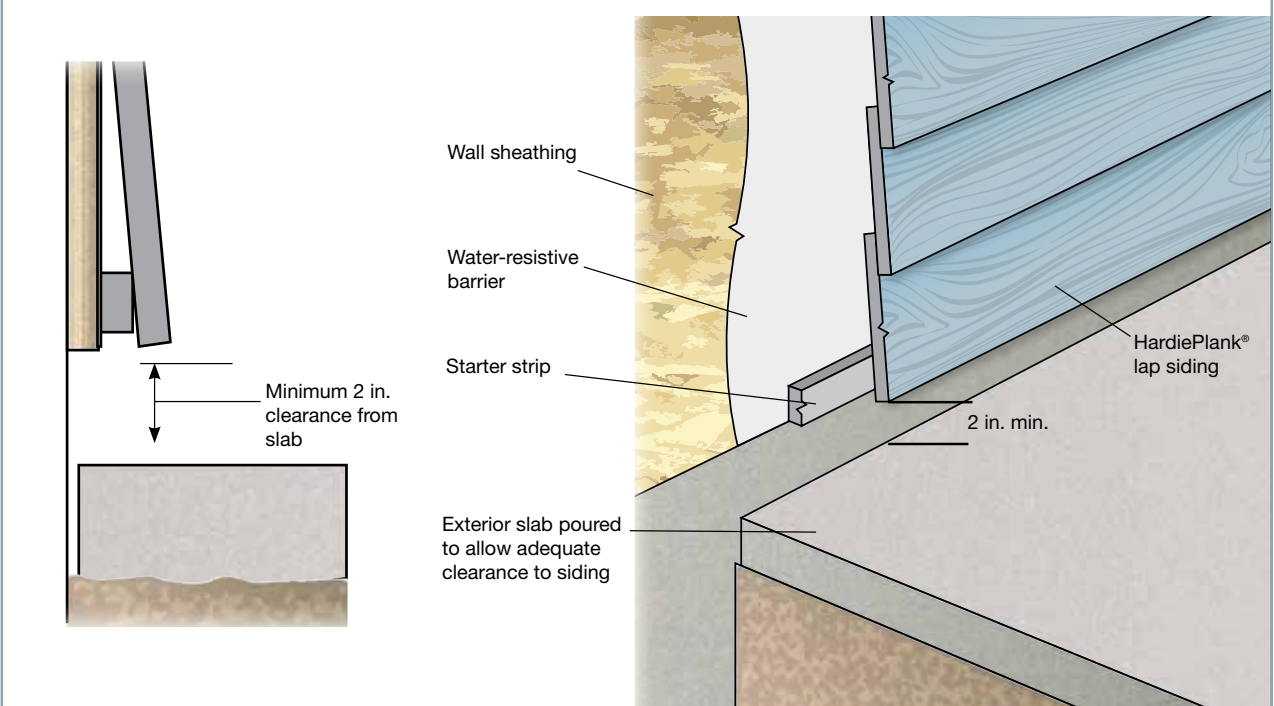

4.37 Wall to exterior slab intersection with decorative counter flashing

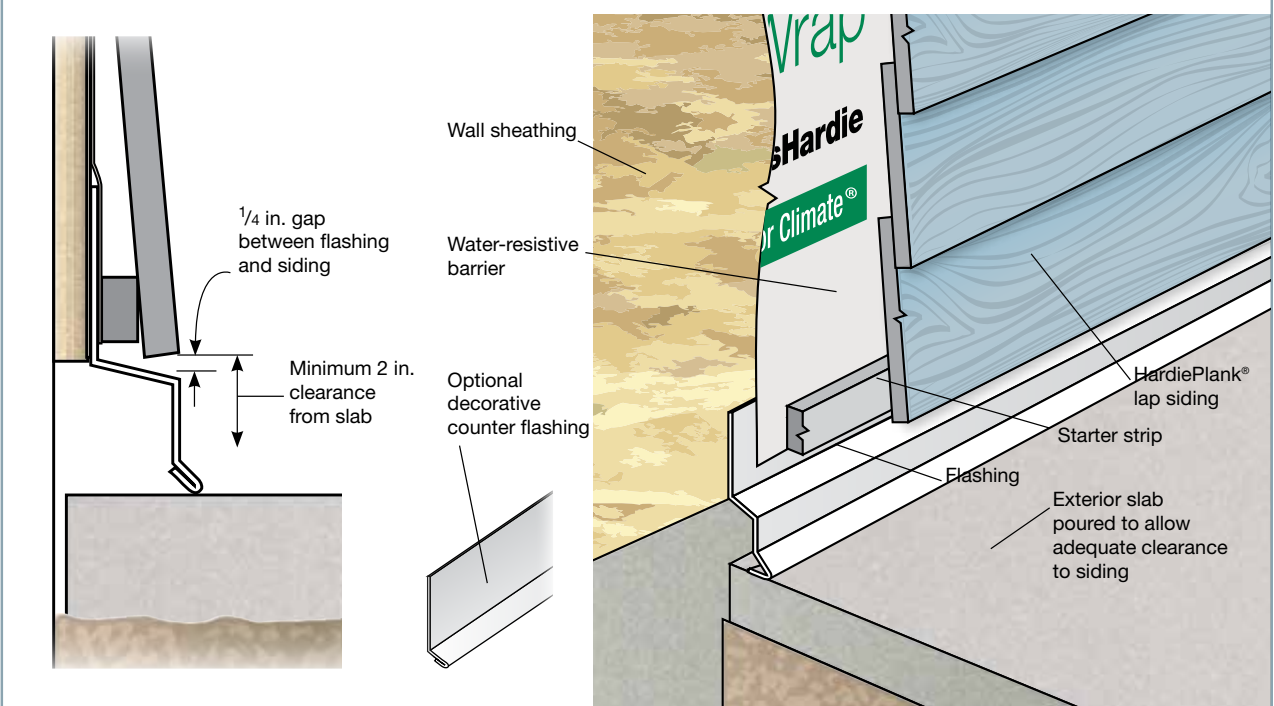

# General Installation Requirements (cont.)

**4.38 Wall to deck intersection without decorative counter flashing**

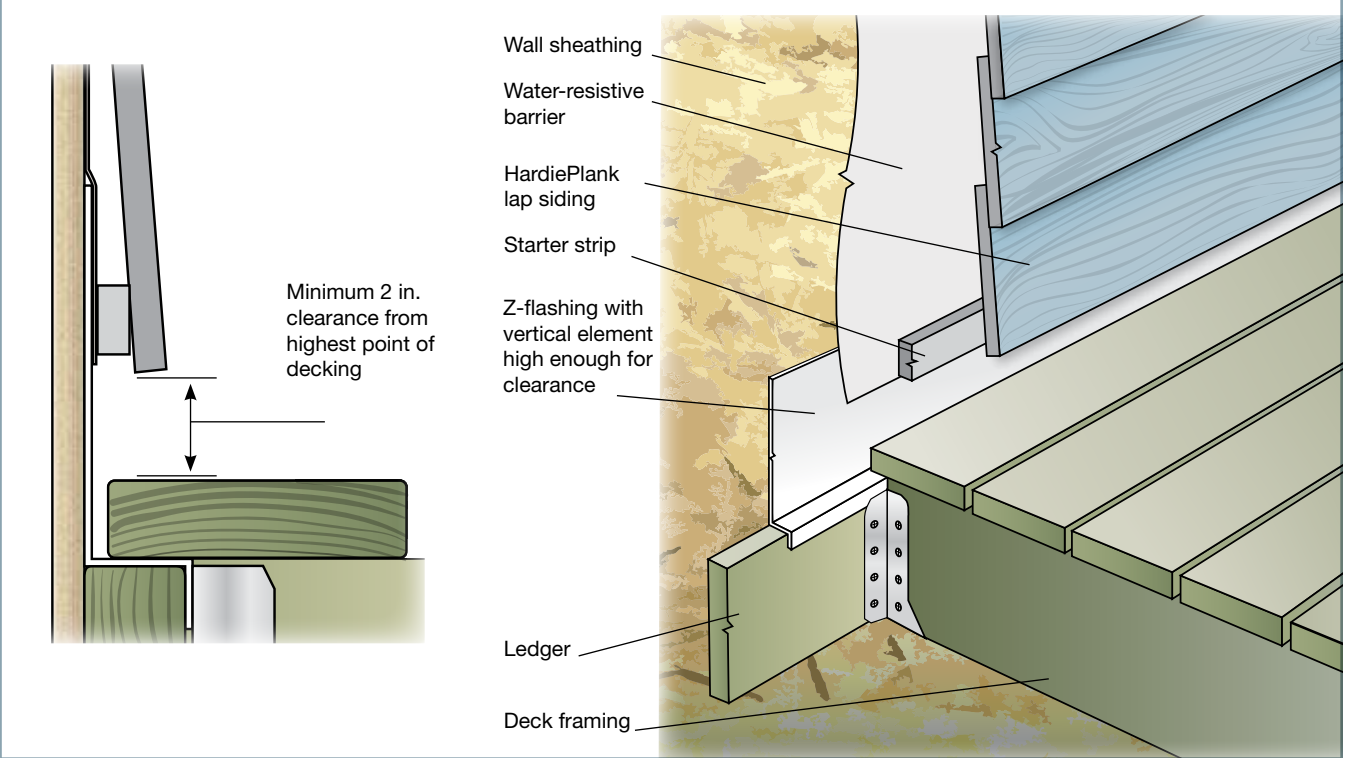

**4.39 Wall to deck intersection with decorative counter flashing**

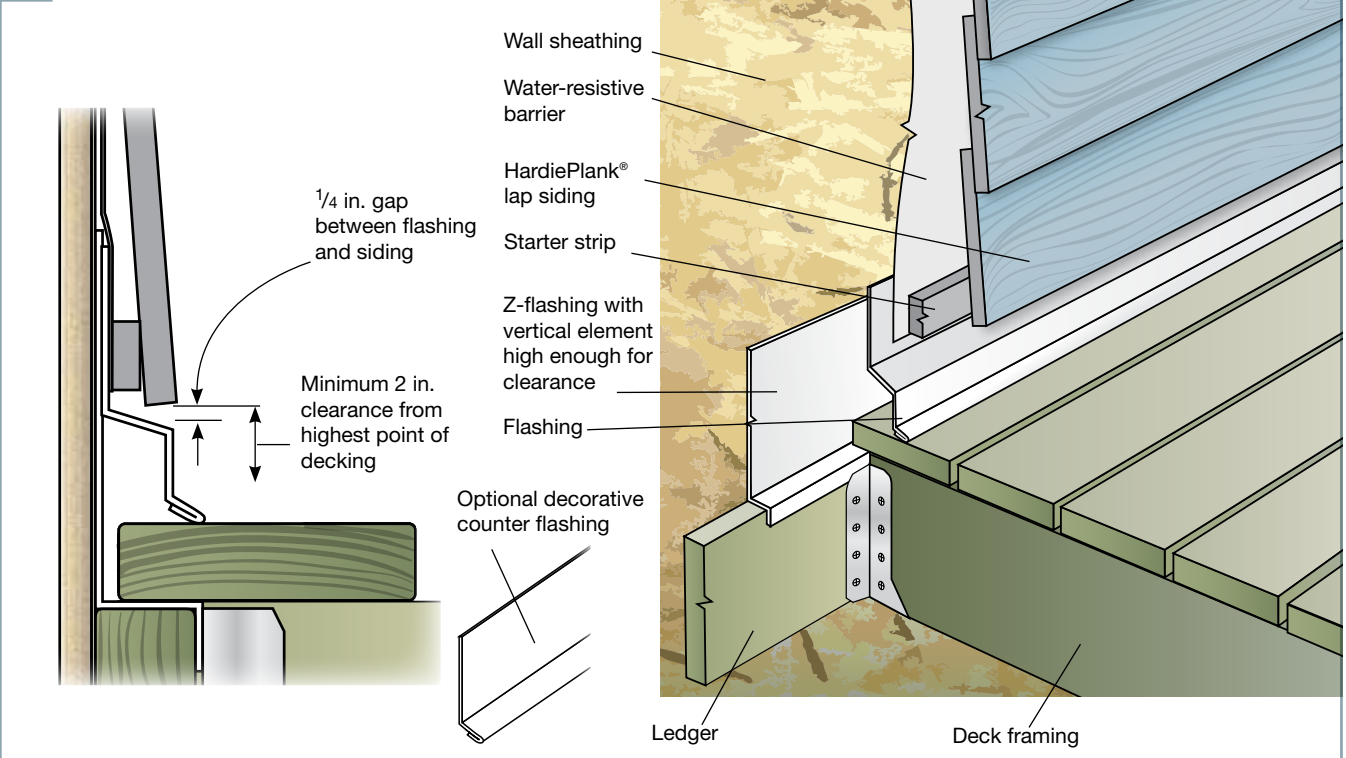

# General Fastener Requirements

Each product section of the James Hardie Installation Guide contains fastener requirements for that specific product. In general if siding is to be installed over a non-structural sheathing such as foam, gypsum, or builder board, increase the length of the fastener by the thickness of the non-structural sheathing. For example, if a 1 ¼ in. fastener would normally be required for an application, but the siding is being installed over ½ in. foam sheathing, increase the fastener length by ½ - ¾ in. fastener length. For siding installation over a framed wall with structural sheathing such as plywood or OSB, the fastener length does not need to be increased.

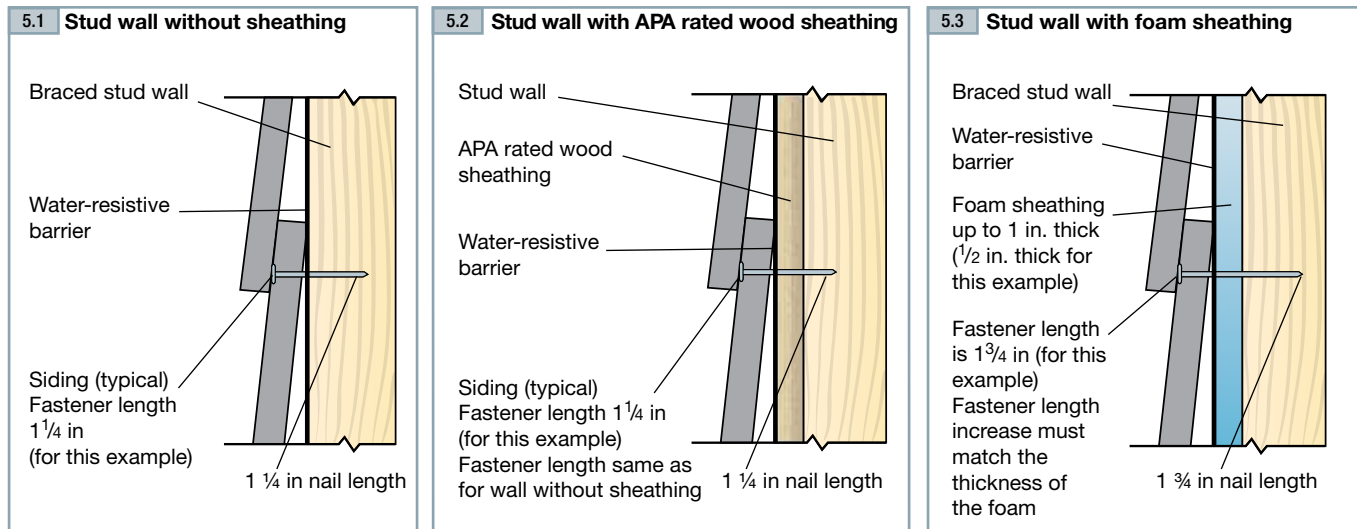

## WARNING

When installing siding over foam sheathing, care must be taken not to overdrive the nails and compress the foam. The resulting unevenness in the wall could distort the siding and give the wall an unsightly wavy appearance.

## PNEUMATIC FASTENING

James Hardie® siding and trim products can be hand-nailed or fastened pneumatically. However, fastening with a pneumatic nailer is recommended for speed and consistency. Nails should be driven snug or flush with the surface of the siding.

For pneumatic nailing, set the air pressure so that the nails are driven to the proper depth. A flush mount attachment on the head of the nailer is recommended. If setting the nail depth proves difficult, choose a setting that slightly under-drives the nails. Then drive any under-driven nails snug to the surface with a smooth-faced hammer.

If nails are driven too deep, countersink them with a nail set, and fill, then drive another nail near by to the proper depth. Never use staples to attach James Hardie products.

**TIP:** Stainless steel fasteners are recommended when installing James Hardie products.

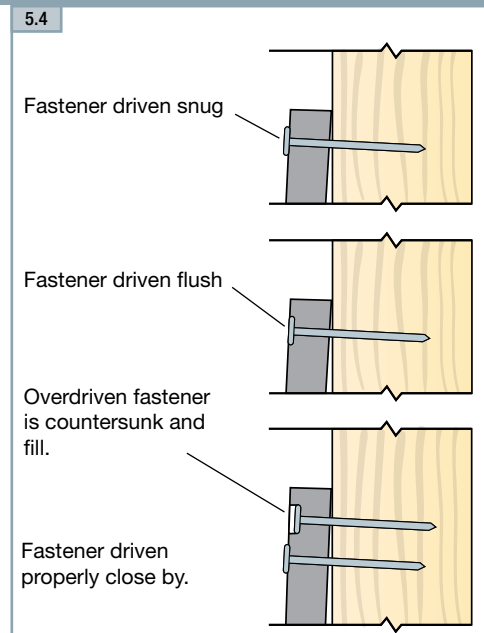

## FINISHING JAMES HARDIE® SIDING AND TRIM PRODUCTS

For best results when painting factory-primed James Hardie® siding and trim products, use high-quality exterior-grade acrylic topcoats. For best results with unprimed James Hardie siding and trim products, prime first with exterior-grade acrylic primer, and then finish with high-quality exterior-grade acrylic topcoats. Two finish coats of paint are recommended.

Use primers and topcoats that are designed and recommended for cement-based building materials such as fiber-cement, masonry, brick or stucco.



### WARNING

- Finish factory primed James Hardie siding and trim products within 180 days of installation.
- The use of oil-based paints on unprimed fiber cement could result in increased surface roughness, loss of adhesion, cracking or excessive chalking.
- DO NOT use stain, oil/alkyd base paint, or powder coating on James Hardie® Products.
- Never apply paint to saturated product.

## COLORPLUS® TOUCH-UP

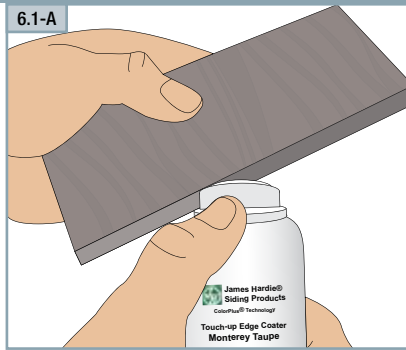

**Edge Coater** - edge coating is required for any field cuts to seal the edges and make joints less visible.

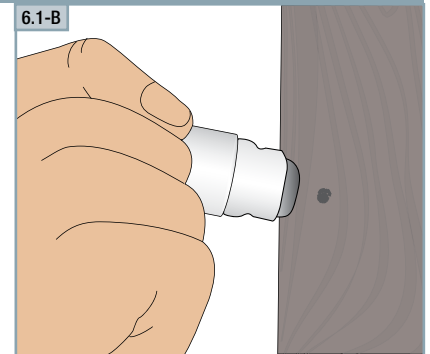

**Touch-up Pens** - conceal nailheads and very small nicks and scratches less than a dime size. Replace the area with a new piece of plank or panel if area is larger than a dime.

**Note:** Edge Coaters or Touch-up Pens should not be used to touch-up any area that is larger than a dime.

**Note:** James Hardie [JH] does not approve caulk (including JH Color matched caulk), other caulking or cementitious patching compounds to touch up nail heads, nail holes, dents, cracks or other minor surface blemishes on JH ColorPlus products.



### WARNING

Do not allow ColorPlus touch-up to freeze. Apply touch-up when temperature of the air and the siding products is above 40°F (4°C).

## COLORPLUS® PRODUCTS WITH PROTECTIVE LAMINATE SHEET

When installing HardieTrim® 5/4, 4/4 boards with ColorPlus® Technology, leave the protective laminate sheet on the board during cutting and installation. To install HardieTrim 5/4, 4/4 boards with ColorPlus® Technology, first fasten the trim using a finish nailer with the nails driven through the laminate sheet. Using a touch-up pen that matches the color of the trim, cover up the nail heads through the laminate sheet at the point of entry. After the nailing and touch-up are complete, remove the protective laminate sheet.



When installing other products such as HardiePlank® Lap Siding and HardiePanel® Vertical Siding with ColorPlus® Technology, leave the protective laminate sheet on the board during cutting and installation. Once the product is installed the laminate sheet should be removed.

**TIP: As with any pre-finished building product, care should be taken when handling and cutting James Hardie ColorPlus products. At the job-site use a soft cloth to gently wipe any residue or construction dust left on the product**

## CAULK

James Hardie recommends the use of caulks and sealants that remain permanently flexible. Look for the words “permanently flexible” written clearly on the label or in the accompanying literature.

For best results, use an Elastomeric Joint Sealant complying with ASTM C920 Grade NS, Class 25 or higher, or a Latex Joint Sealant complying with ASTM C834. Caulking/sealant must be applied in accordance with the caulking/sealant manufacturer’s written instructions.

James Hardie does not warrant and does not accept liability for the appearance or the performance of field-applied caulks and sealants.

## REPAIR PATCHING

Dent, chips, cracks and other minor surface damage in James Hardie primed siding and trim products can be filled with cementitious patching compound except on ColorPlus. When repairing holes of less than 1 in. that has been created by scaffold anchors, pipe, etc. James Hardie recommends a backer rod be placed into hole and sealed to prevent water infiltration. James Hardie will assume no responsibility for water infiltration.

## BACK PRIMING/BACK SEALING

James Hardie does not require any of its siding products to be back sealed or back primed prior to installation in the field.

## MAINTENANCE

This maintenance instruction applies to all James Hardie® products, including PrimePlus® and ColorPlus® Technology.

Always follow the instructions and precautions outlined in the James Hardie® ColorPlus® Technology literature that was supplied with the product and the information that is available on the James Hardie® website ([www.jameshardie.com](http://www.jameshardie.com)), including James Hardie ColorPlus Technology instructions and precautions

The extent and nature of the maintenance required will depend on the geographical location, the exposure of the building and whether your product is prime or ColorPlus product. Cleaning, as needed, is recommended to remove dirt, dust, chalking, oil, grease, organic contaminants, or mold that may build up on the product surface over time. Dust from cutting and construction dust should be removed IMMEDIATELY upon installation (refer to the cleaning instruction in the table below). During cleaning, always wear appropriate protection (gloves and eyewear) and shield any landscaping or vegetation.

Surface cleaning recommendation is given below for specific product conditions. (Please note that damage to siding arising from improper cleaning or maintenance may not be covered by the James Hardie warranty).

Recommendation	Construction/Cutting/ Existing Dirt and Chalk	Oil, grease or other organic contaminants	Mold and Mildew
Tools	Soft cloth, soft All Paint poly brush or chip brush or horsehair bench brush, garden hose. (Do not use hard brush (for example, scrub brush or an abrasive scrub sponge) that could damage the finish or siding.	Soft cloth and garden hose	Soft cloth or soft sponge and garden hose
Solution	Water	Mild liquid dishwashing soap (Dawn®, Ivory®, or Joy®) and water. (Do not use any harsh cleaning chemicals)	Mildew cleaners (Jomax®, Mildew Check®, Mold Armor®) and water
Method	<ol style="list-style-type: none"> <li>1. If using a brush, brush the product surface dust, dirt or chalk, then rinse the area with a garden hose.</li> <li>2. If using a soft cloth, wet the cloth then wipe the area until clean and rinse the area with clean water. Rinse the cloth frequently.</li> </ol>	<ol style="list-style-type: none"> <li>1. Use soft cloth wetted with soapy water to clean the area. Rinse the cloth frequently.</li> <li>2. Use a garden hose to rinse the area.</li> </ol>	<ol style="list-style-type: none"> <li>1. Follow the mildew cleaner instruction.</li> <li>2. Lightly scrub the area with mildew.</li> <li>3. Use garden hose to rinse the area.</li> </ol>

Soft All Paint Brush



Horsehair Brush



Chip Brush



Siding Brush



It is always suggested to work a small section at a time, start from the top and work your way down to prevent dripping or streaking onto the cleaned area.

Gently clean the siding with the soft brush or wet soft cloth in a side to side motion in the direction of the plank siding. If cleaning panel, direction of the siding is up and down. Do not push soft brush or wet cloth too hard against product surface. Do not allow the soap and mildew cleaner to dry on the siding (continually rinse the area until all of the cleaner has washed off of the siding). Any areas that have been missed may show up when the siding has dried. Spot clean and rinse any missed areas as needed.

If your surface still looks dirty after washing methods for dust/dirt and oil/grease, the problem may be mildew. Mildew discoloration can resemble dirt. Moisture is the most important single factor in the growth of mildew, which can lie dormant for years. For this reason, mildew discoloration is usually found in damp, dark areas or during prolonged humid conditions. Follow all instructions and precautions that are outlined on the label of the mildew cleaners and wear all protective equipment that is prescribed.

At all times, care must be taken not to use harsh or harmful chemicals that can damage the finish on the siding.

**WARNING**

High pressure water blast and sand blasting may damage the surface of the fiber cement product. Low pressure water spray, a soft medium bristle (nonmetal) brush is most suitable for cleaning fiber cement products. Acid washing can damage the fiber cement surface and is not recommended.

Note: If using a pressure washer, care must be taken to ensure that the water stream does not damage the surface of the siding. Damage to siding arising from improper cleaning or maintenance may not be covered by the James Hardie warranty. Using wide fan tips that are kept a minimum of 6 feet from the wall and at pressures under 1500 psi will minimize the chance of damaging the siding.